

CAPS

S153-KOM4S/50

A	B	C		D
1	S153-0003	433	188	1/2
2	S153-0004	433	188	1/2
3	S153-1101	843	399	1/2
4	S153-1102	843	399	1/2
5	S153-2202	504	403	1/2
6	S153-3302	438	383	1/2
7	S153-571	188	100	2/2
8	S153-572	70	100	2/2
9	S153-9903	807	230	1/2
10	S153-9904	400	348	1/2
11	ZS2-511	350	120	1/2
12	ZS2-512	350	120	1/2
13	ZS2-5582	389	120	1/2
14	LH-777	777	14	1/2

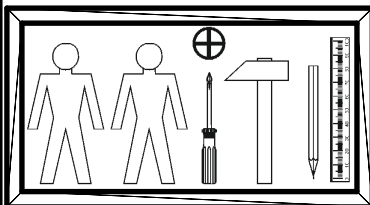
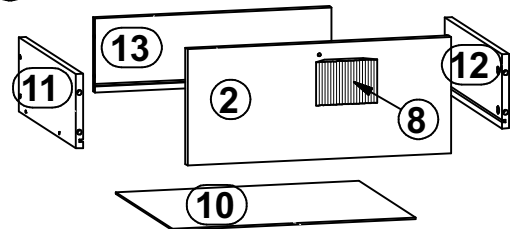
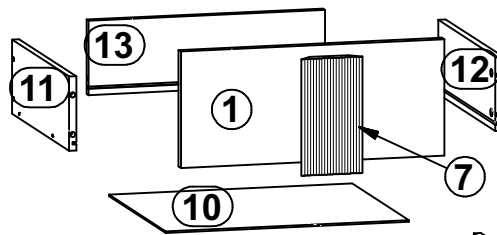
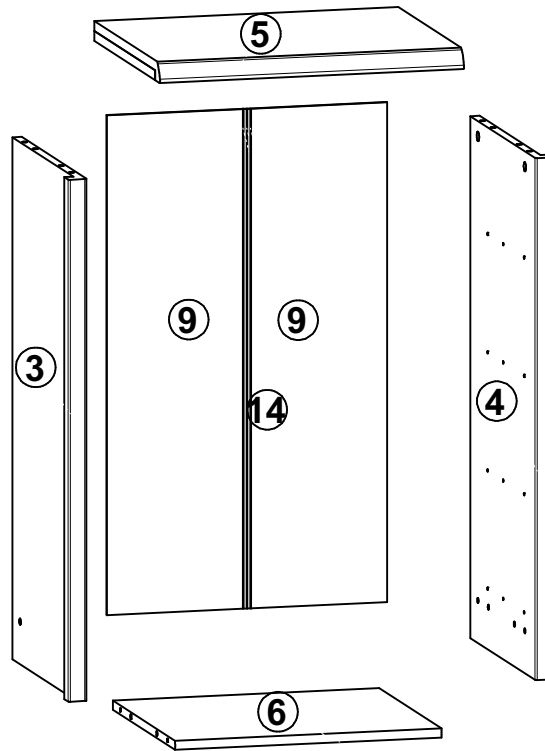
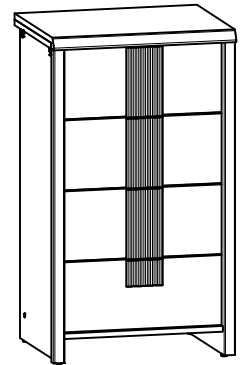

4x φ7x50 mm e1	16x φ5x9 mm e19	24x φ6x13 mm e3	8x φ8x30 mm f1	16x φ6.5x40 mm f25	4x k1	30x l1	8x φ4x22 mm p60	4x φ1.5x12mm #16 r1
16x φ12x10.5mm #12 r15	20x r42	4x 350 mm w45\CL	4x 350 mm w45\CR	4x 350 mm w45\DL	4x 350 mm w45\DR	1x z1	1x n2611	1x φ3.5x16 mm p38
4x s1	2x ø16 s2							

1

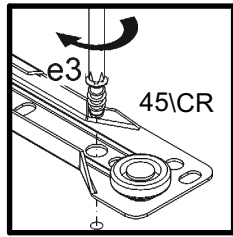
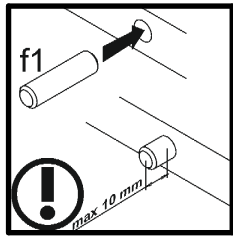
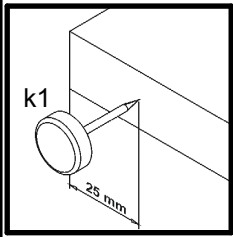
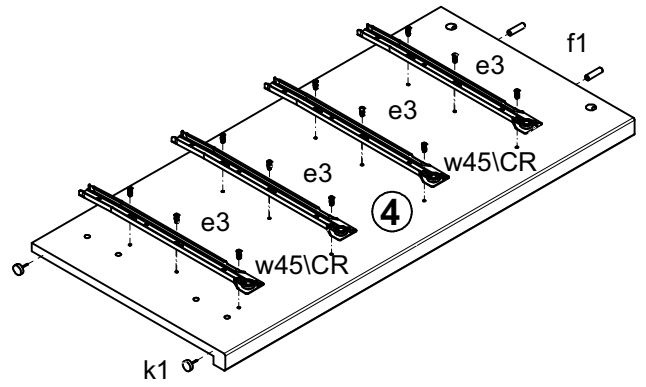
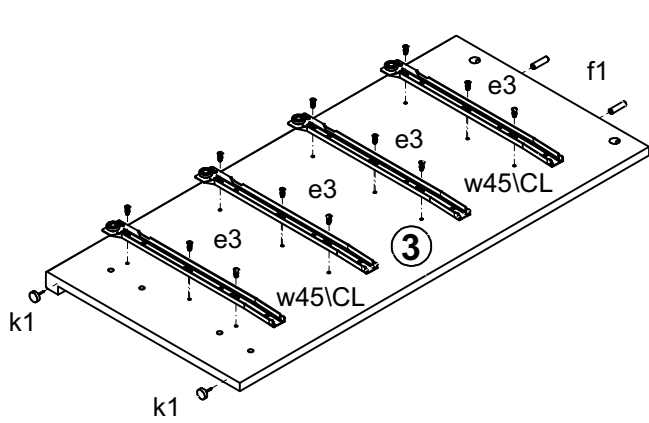

2

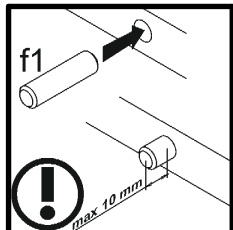
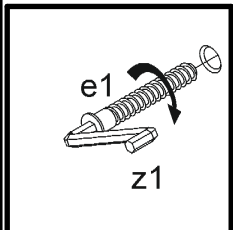
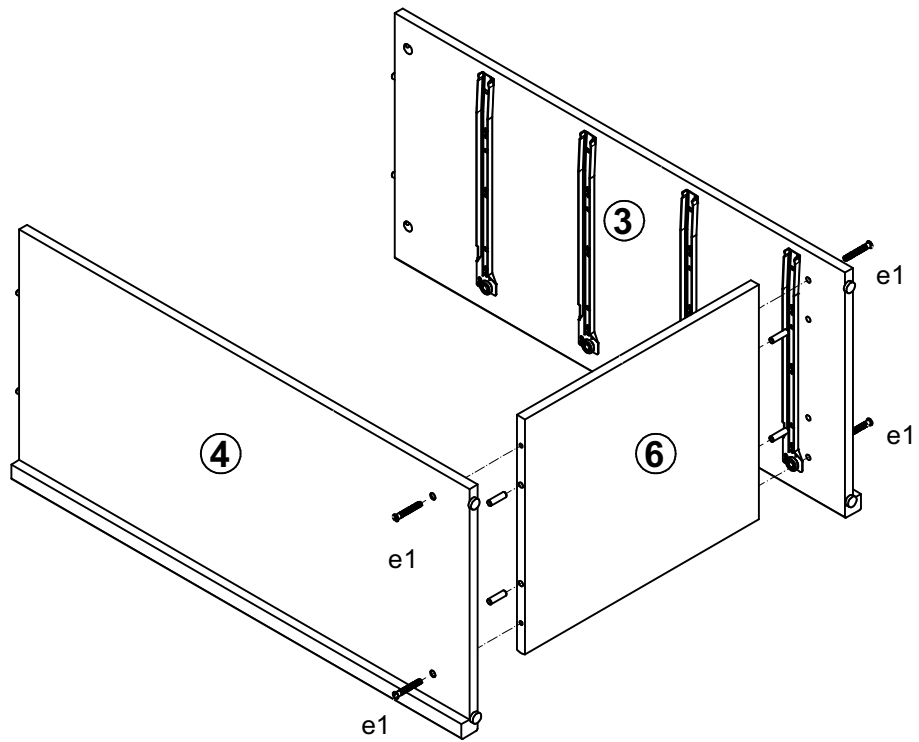

3

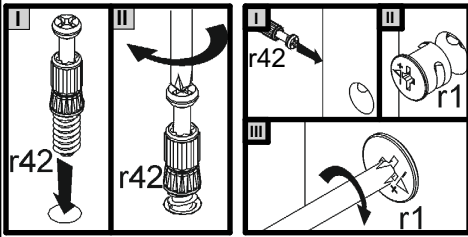
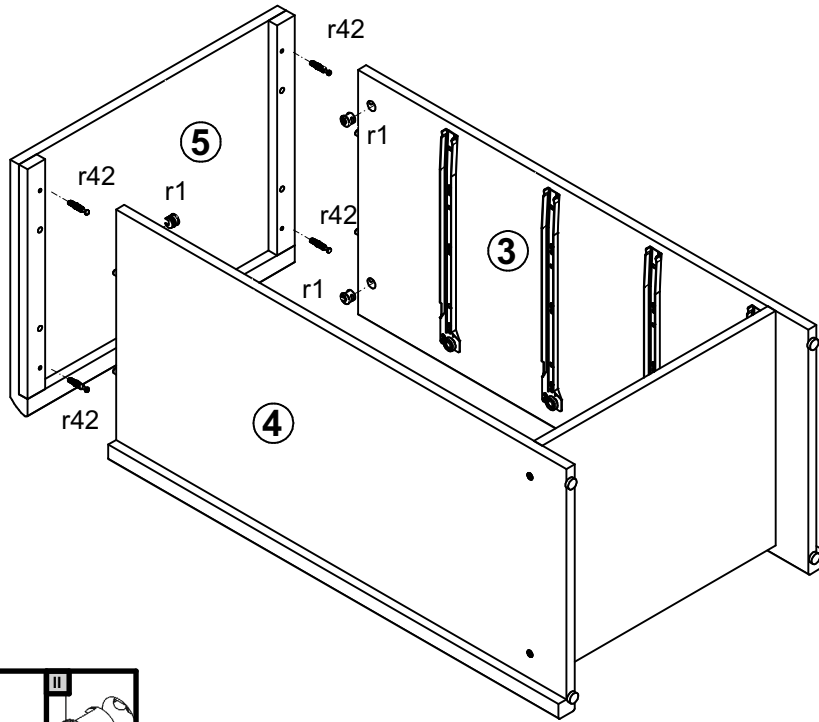

4

